

# 3" COMPACT FLOPPY DISK DRIVE

## HFD305SE

### USER'S GUIDE

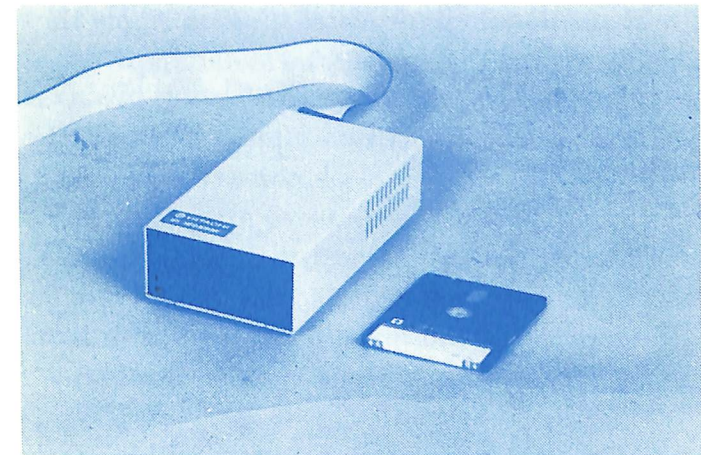

## TABLE OF CONTENTS

1. INTRODUCTION
2. KEY FEATURES
3. CAUTIONS ON USE
4. INSTALLATION INSTRUCTIONS
  - 4.1 APPLE II and APPLE II plus COMPUTERS
  - 4.2 APPLE IIe COMPUTERS
5. OPERATION INSTRUCTIONS
6. TECHNICAL INSTRUCTIONS
7. COMPACT FLOPPY DISK

## LIST OF FIGURES

- FIGURE 1 : Items Required for Installation on Apple II, II plus  
FIGURE 2 : Positioning the Cable in the Clamp  
FIGURE 3 : Items Required for Installation on Apple IIe  
FIGURE 4 : Placing the Clamp over the Metal Flap  
FIGURE 5 : Positioning of the Clamp  
FIGURE 6 : Compact Floppy Disk

## 1. INTRODUCTION

The HFD305SE is a valuable addition to your Apple II, IIplus, or IIe \* computer. Several individual files can be stored on each disk and each file can be accessed directly, by name. The HFD305SE also offers you the convenience and durability of 3" cartridge-type media. This guide will discuss the installation and operation of the HFD305SE.

Before using the HFD305SE, please review any disk drive related sections of your Apple II manual and your Disk Operation System (DOS) manual.

## 2. KEY FEATURES

- 1) The HFD305SE is compact size and light weight compared with 5.25" floppy disk drive.
- 2) The HFD305SE provides up to 143K bytes of on-line, formatted storage capacity under Apple DOS 3.3. By manually flipping the disk, an additional 143K bytes can be accessed.
- 3) The HFD305SE is fully compatible with Apple DOS 3.3 providing 35 tracks, 16 sectors.
- 4) Easy operation with One-touch load and eject mechanism.
- 5) 3" cartridges are constructed of hard plastic and feature an automatic shutter mechanism which protects the media until it is inserted into the drive. In addition, the cartridge contains a built-in "Write Protect" mechanism.

---

\* NOTE: Apple II, II plus, and IIe are registered trademarks of Apple Computer Inc..

---



### 3. CAUTIONS ON USE

- **KEEP WATER OUT**  
When water or liquid enters the set, they can cause trouble.  
Immediately remove the power plug and contact your dealer.
- **KEEP IN A WELL-VENTILATED PLACE**  
Ventilation holes are provided in the cabinet to prevent the temperature from rising.  
Do not: 1) Place the unit in a poorly ventilated location, 2) Cover the unit with a cloth or, 3) Place the unit on a carpet as this clogs the ventilation holes.
- **HIGH TEMPERATURE CAUSES TROUBLE**  
Avoid placing the unit in direct sunshine, near a heating appliance, or where lamp soot will directly contact the unit such as in a kitchen.
- **DO NOT APPLY SHOCK**
- **WHEN BEHAVIOR IS ABNORMAL**  
When any abnormal sound, odor, or smoke is detected, turn the power switch off, and contact your dealer.
- **DO NOT LET FOREIGN MATTERS IN UNIT**  
When metals or inflammables are inserted or dropped through the ventilation hole, they can cause trouble.
- **KEEP IN A PLACE WITH MINIMUM MOISTURE OR DUST**  
Do not place the unit in a place with much moisture or dust such as inside a bathroom or near a washing machine.
- **WHEN THE UNIT IS NOT USED FOR A LONG TIME**  
Be sure to remove the power plug from the socket when you are going on a trip, etc., and the unit will not be used for a long time.



Floppy disc marked  can be used with this floppy disk drive.

### 4. INSTALLATION INSTRUCTIONS

#### 4.1 APPLE II and APPLE II plus COMPUTERS

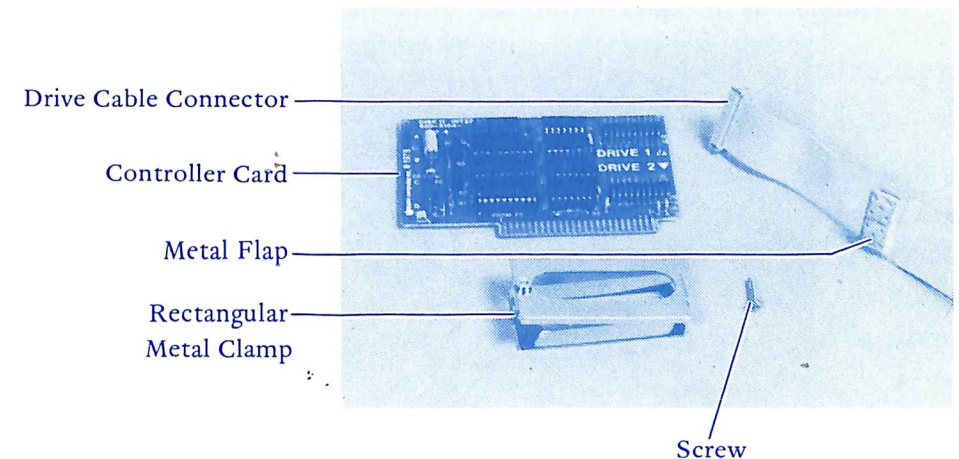

FIGURE 1 Items Required for Installation on Apple II, II plus



## INSTALLATION STEPS

- A) Turn off the power switch at the rear of the computer and power down any other attached peripherals. For maximum safety, remove the power cord from the wall.
- B) Reach behind the computer and pull up on the back corners of the cover until the corner fasteners snap apart. Remove the cover and set it on its side.
- C) Touch the power supply along the left side of the computer to discharge any static charge that could be on your clothes or your body.
- D) Remove the clamp and screw (See Figure 1) from their container. Note that a small round nut is attached to one side of the clamp, centered over the holes in the clamp. With one hand, squeeze together the sides of the clamp. With your other hand, slide the screw into the hole in the side of the clamp farthest from the nut. Slide the screw through to the side of the clamp with the nut. Then turn the screw a few times until its end is flush with the nut.

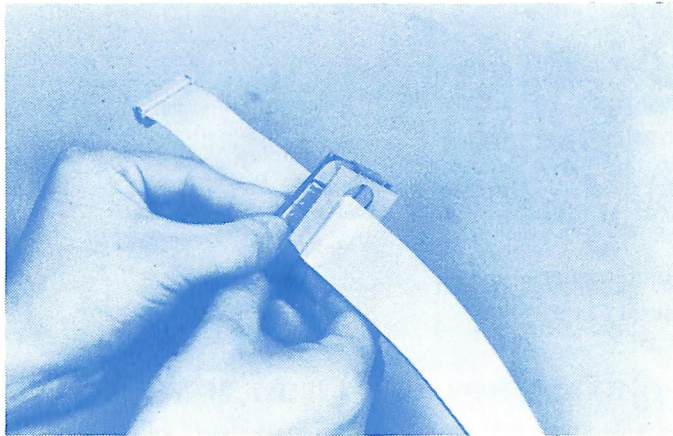

FIGURE 2 Positioning the Cable in the Clamp

- E) Slide your disk drive's cable connector through the opening in the metal clamp. Be certain the screw head on the metal clamp

faces the disk drive. Pull the cable through the clamp until the cable's metal flap fits between the two sides of the clamp as shown in Figure 2. (The metal flap should fit comfortably into the curl formed by the outer edges of the clamp)

- F) Now, locate the three deep, vertical notches in the back of the computer's case. Position the clamp over the third deep notch from the left (as seen from the keyboard side of the computer).
- G) Hold the cables and clamp in the arrangement described in step E for the number of drives that you are installing. Taking care not to scratch the paint inside the computer's case, slide the clamp over the third notch from the left, making certain that:
  - The side of the clamp with the screw head visible is **OUTSIDE** the computer.
  - The screw goes down into the notch first so that the clamp's label **TOP** is facing up.
  - The drive cable's metal flaps are **INSIDE** the computer, held flat against the inside of the case in the positions described above and not sticking out from under the curled edges of the clamp.
  - The metal flaps fit snugly under the curled edges of the clamp, and do not overlap one another.
- H) Gently push the clamp as far down into the notch as it will go. Tighten the clamp screw from the outside of the computer making certain the flaps of the disk cables are held **TIGHTLY** against the inside of the computer's case by the metal clamp. As you do this, check to make sure that all the conditions listed in Step G are met.
- I) Finally, plug the connector onto the pins of the controller in the same manner that you would plug the connector of a Disk II drive. **BE CERTAIN** that the pins line up with the matching holes in the connector, that there are **NO** pins or holes left over on either end and that the cable exits the connector away from the controller card.



## 4.2 APPLE IIe COMPUTERS

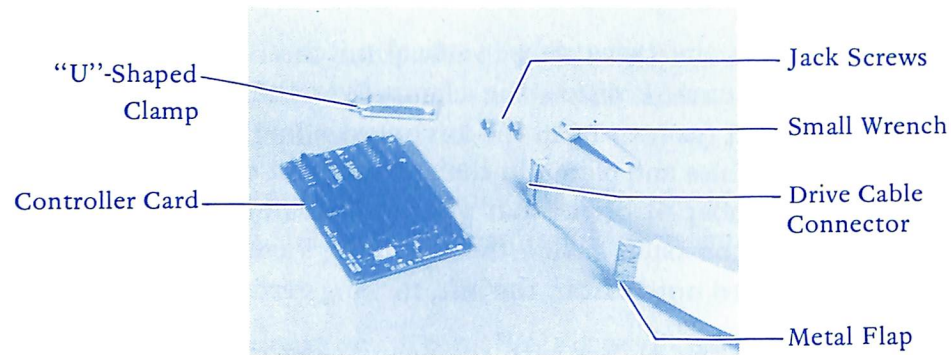

FIGURE 3 Items Required for Installation on Apple IIe

### INSTALLATION STEPS

- A) Turn off the power switch at the rear of the Apple IIe and power down any other attached peripherals. For maximum safety, remove the power cord from the wall.
- B) Reach behind the computer and pull up on the back corners of the cover until the corner fasteners snap apart. Remove the cover and set it on its side.
- C) Touch the power supply along the left side of the computer to discharge any static charge that could be on your clothes or your body.
- D) Look at the back panel of your computer and you will see 12 cover plates which are used to seal access holes to the expansion slots. Notice that each cover plate has a number printed beside it. You should only be concerned with the openings numbered 1 through 4. Remove one cover plate for each disk drive you install beginning with cover plate # 1.

- E) Looking at the disk drive's ribbon-like cable, (Figure 3) you will note that it has a connector at its end, and a metal flap on its side. Feed the connector end through the lowest numbered opening available on the back panel of the computer. Then, find the "U"-shaped clamp and two jack screws (Figure 3) that came packed with your drive.
- F) Take hold of the cable and bend the metal flap away from the connector. Now, hold the flap down against the cable with your thumb. Hold the "U"-shaped clamp in your other hand in such a manner that the raised "BUMP" on one side of the clamp is under your thumb, and the opening in the clamp is facing up.
- G) Place the cable and folded-over metal flap into the clamp so that the flap is pressed against the cable and positioned between the two sides of the clamp. (You may need to spread the clamp open slightly to allow room for the flap. See Figure 4.)

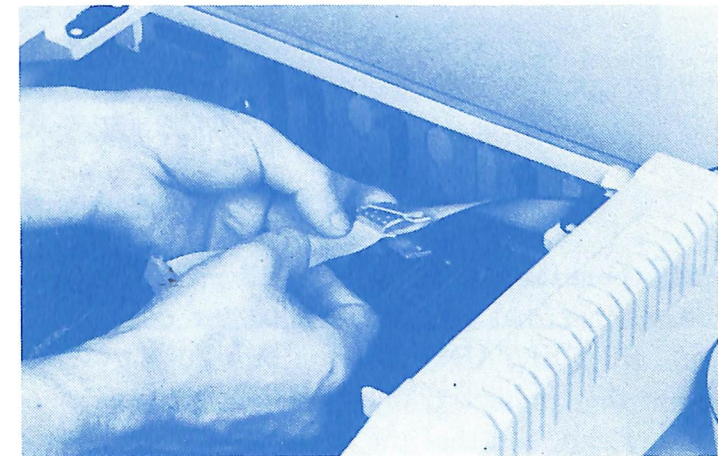

FIGURE 4 Placing the Clamp over the Metal Flap



- H) At this point, feed the cable back through the opening until the clamp touches the back panel. Push the clamp against the back panel so that the bump fills the opening, and the two round nuts attached to the clamp are facing you.
- I) Hold the clamp against the opening with one hand as shown in Figure 5. Reach behind the computer with the other hand, and install screws through the two slots on the top and bottom of the opening into the nuts on the clamp.

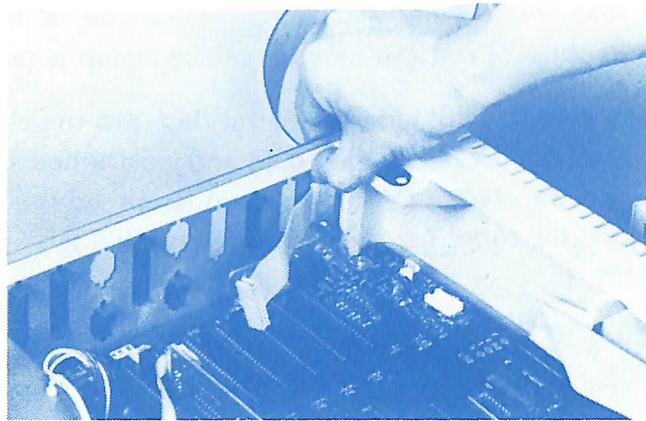

FIGURE 5 Positioning of the Clamp

- J) Finally, plug the connector onto the pins of the controller in the same manner that you would plug the connector of a Disk II drive. BE CERTAIN that the pins line up with the matching holes in the connector, that there are NO pins or holes left over on either end, and that the cable exits the connector away from the controller card.

## 5. OPERATION INSTRUCTIONS

The operation of the HFD305SE is very simple and straightforward. Except for the different type of media which it employs, it operates in

the same manner as the Disk II drive from Apple. To operate the drive, simply insert the 3" Disk through the disk door of the drive and you are ready to go. After you finish your task, simply press the eject button located on the front of the drive directly below the disk door and remove 3" Disk. To record on the opposite side of 3" Disk, simply flip it over as you would a cassette tape.

## 6. TECHNICAL INSTRUCTIONS

- 1) This compact floppy disk drive is used as follows.

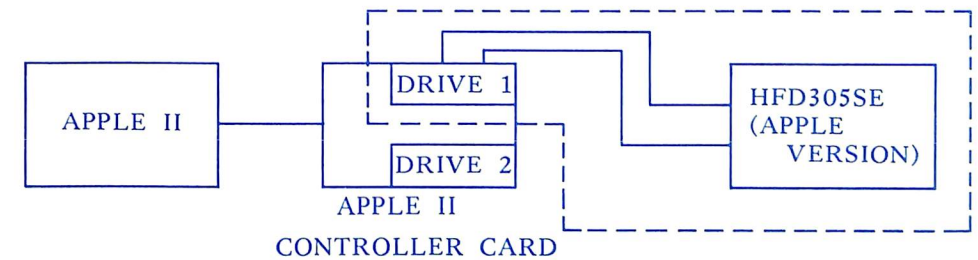

Using DOS Apple II DOS 3.3

## 2) SPECIFICATIONS

Formatted Capacity (Bytes)	Per Surface	143,360
	Per Disk	286,720
Track No.		35
Sector		16
Capacity per Sector (Bytes)		256
Media		3" Compact Floppy Disk
Environmental Limits	Ambient Temperature	10~35°C (Non Operating; -20~50°C)
	Relative Humidity	20~80%RH (Non Operating; Non Condensing)
	Maximum Wet Bulb	29°C (Non Condensing)

### 3) EXTERNAL INTERFACE

- Connector: 20 Pin flat cable male connector
- Signals

Pin NO.	Signal
1, 3, 5, 7	GND
2, 4, 6, 8	$\Phi_0, \Phi_1, \Phi_2, \Phi_3$
13, 15, 17, 19	+12V
14	ENBL
20	Write Protect
16	Read Data
18	Write Data
10	Write Gate
11, 12	+5V
9	-12V (Unused)

### 7. COMPACT FLOPPY DISK

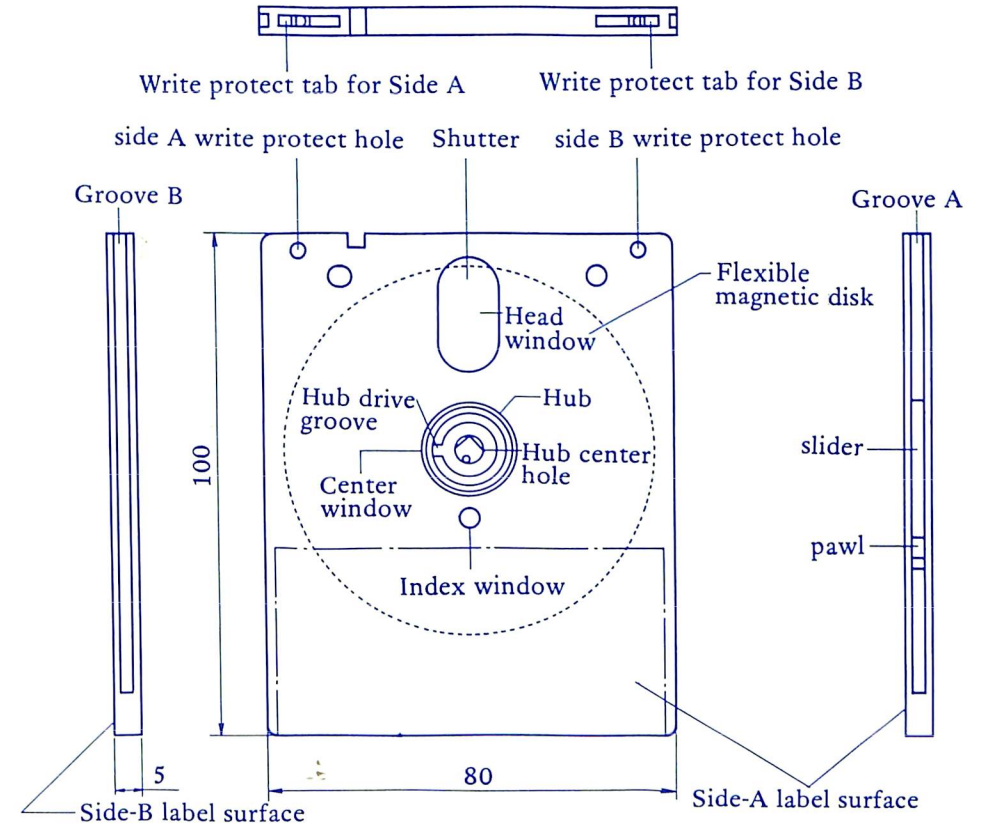

FIGURE 6 Compact Floppy Disk

### Facts to Remember about the 3" Disk

- This compact floppy disk is usable on both sides.
- When using the diskette on Side A, to access Side B simply flip the diskette over as you would a cassette tape.
- To prevent further writing of data to a disk, open the Write Protect holes by sliding the write protect tabs toward the inside with the tip of a ballpoint pen or equivalent implement.

### Handling Precautions

- Do not attempt to open the shutter and touch the disk surface.
- Do not forcibly press the shutter plate or apply excessive force to the opening/closing slider.
- Do not forcibly bend the disk.
- Always keep the hub clean; a deformed or contaminated hub may cause errors.
- Do not use thinner, alcohol, or freon to clean the disk.
- Do not touch the disk with an eraser.
- Avoid eating or smoking around the disk.

### Storage Instructions

- Do not store the diskette in locations exposed to excessive heat, humidity, or direct sunlight.
- Avoid storing in locations where strong magnetism is generated.
- Avoid storing in a location which is liable to cause dust or dirt accumulation.